

MOCOWANIE TYPU

COLLY

*Striving for
excellence*



**PRESS BRAKE
TOOLING AND
EQUIPMENT**

ROLLERI

POLMET

tel/fax 018 3310177

biuro@polmet.biz

tel/fax 018 3312241

www.polmet.biz

COLLY TYPE

HRc 54-60 (1980->2200 N/mm²)

CP200-85-07 42Cr

85° 1020

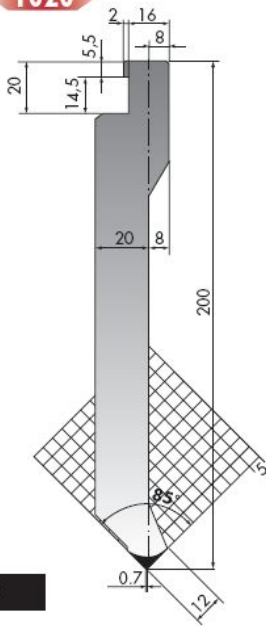

CP200-85-07

CP200-85-07-A 42Cr

85° 1020

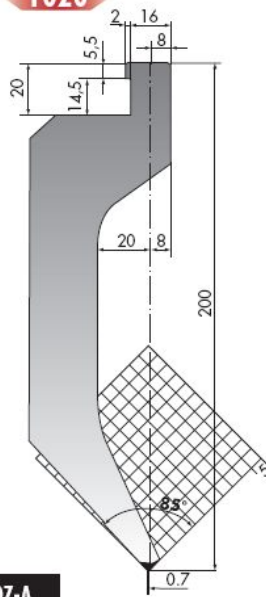

CP200-85-07-A

CP200-50-R1 42Cr

50° 1020

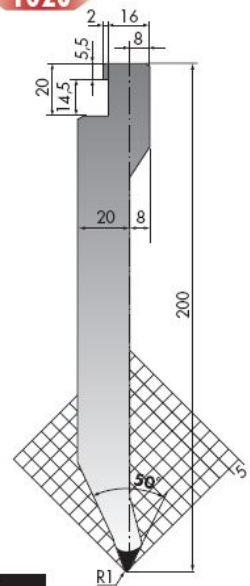

CP200-50-R1

CP200-50-R1-A 42Cr

50° 1020

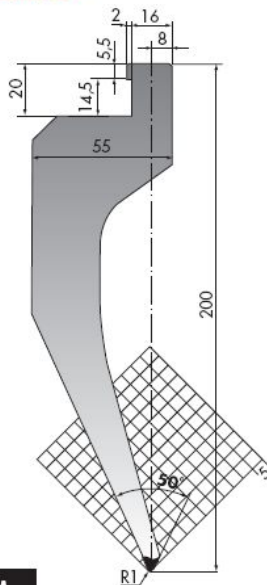

CP200-50-R1-A

CP200-24-R1 42Cr

24° 1020

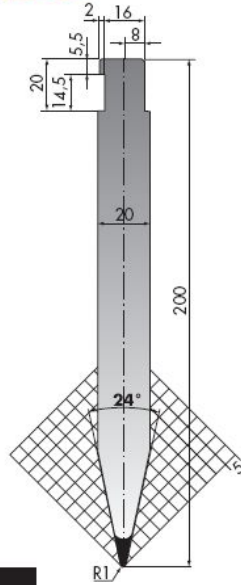

CP200-24-R1

CP

CP200...../F

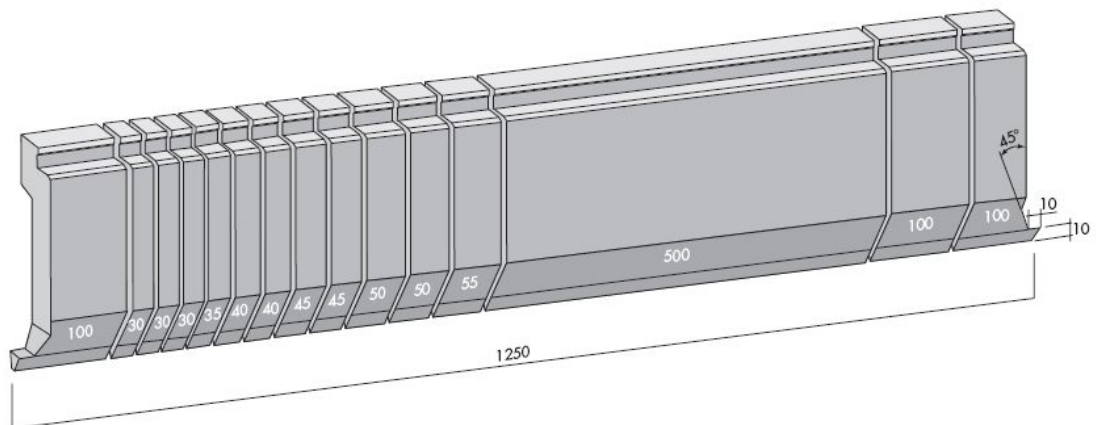

C45 560-710 N/mm²

42Cr 900-1150 N/mm²

COLLY TYPE

HRc 54-60 (1980->2200 N/mm²)

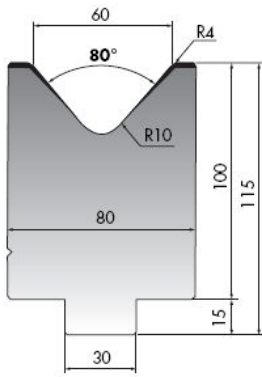

M115-80-60

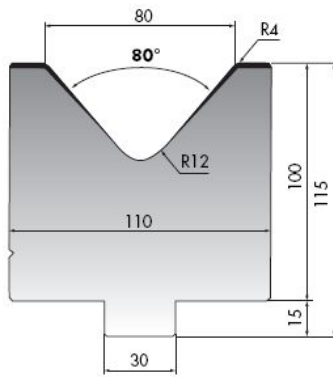

M115-80-80

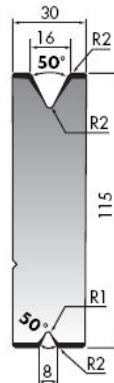

M115-50-16

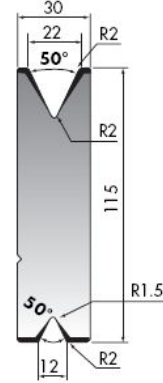

M115-50-22

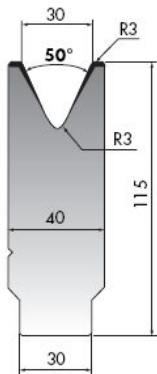

M115-50-30

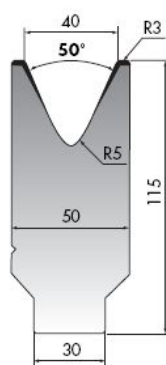

M115-50-40

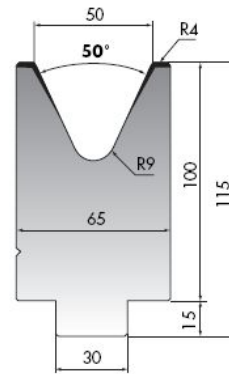

M115-50-50

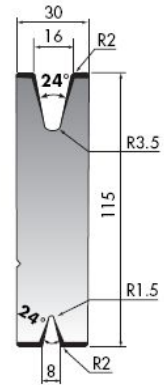

M115-24-16

M115

M115...../F

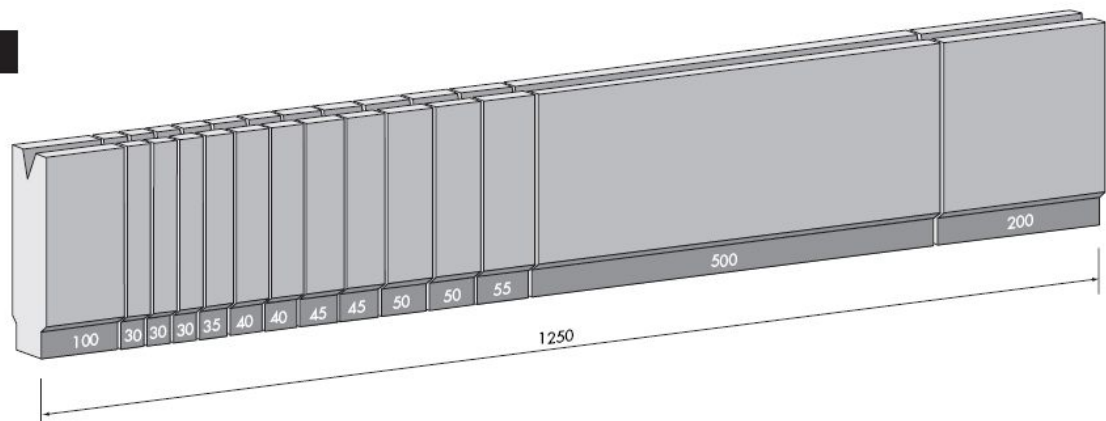

POLMET

Ul. Starowiejska 41
34-730 Mszana Dolna
www.polmet.biz

tel/fax 018 3312241
tel/fax 018 3310177
biuro@polmet.biz



ROLLERI

Rolleri SpA

I-29020 Vigolzone (PC) - Italia - Via Artigiani, 18
Tel. +39 0523 870905 - Fax +39 0523 879030
E-mail: info@rolleri.it - www.rolleri.it